

Kinghelm®

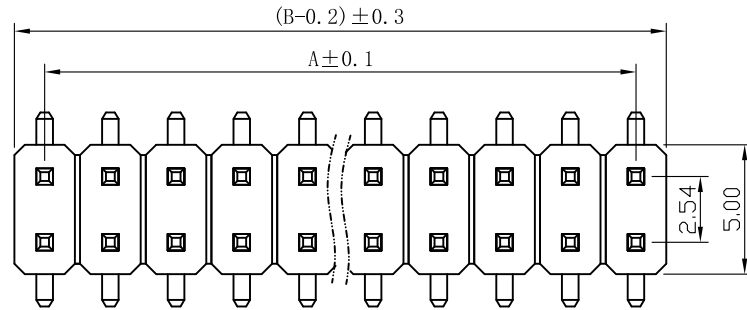

SPECIFICATIONS

Current Rating: 3Amps
 Insulation Resistance: 1000MΩ Min
 Contact Resistance: 20mΩ Max
 Withstanding Voltage: AC 1000V
 Operation Temperature: -40° to +105°
 Contact Material: Brass
 Standard: PA6T
 Insulator Material: Polyester (UL 94V-0)
 Contact Plating: Gold Flash
 Max. Processing Temp: 240° C for 30-60 seconds
 (260° C for 5 seconds)

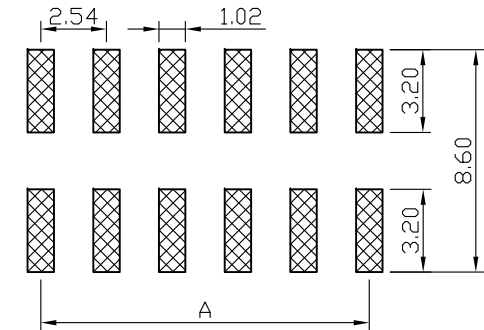
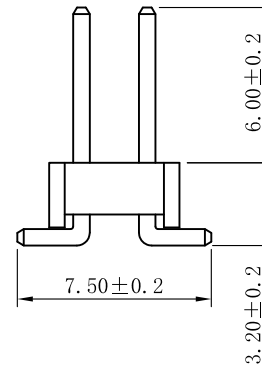
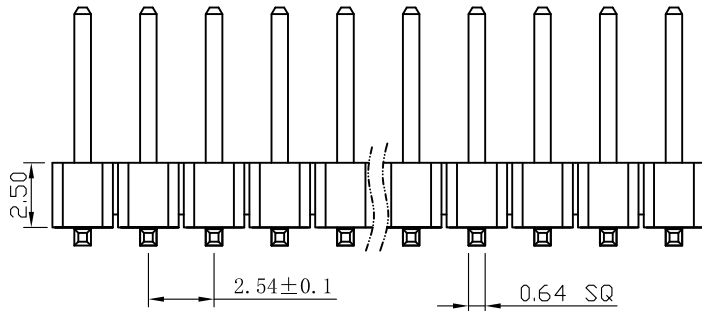

RECOMMEND P. C. B LAYOUT

PCB TOLERANCE: ±0.05 (TOP VIEW)

深圳市金航标电子有限公司

www.kinghelm.com.cn

KH-2.54PH-2X37P-L11.0-SMT

0755-28190160

UNLESS OTHERWISE SPECIFIED TOLERANCE

X : ±0.30 X° : ±5°
 X.X : ±0.25 X.X° : ±1°
 X.XX : ±0.20 X.XX° : ±0.5°

DRAWN NAME: 2.54PH H2.5 2xnPin SMT PC7.5 PA6.0 PB3.2 L11.0 6T

SIZE	A4	SCALE	N:1	PROUCT NO.
REV	A	UNIT	mm	PROJECT

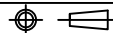

PAGE 1/1

CHECKED: 陈超凡 2022/04/24 CHECKED: / / APPROVED: / /

No. of	DIM. A	DIM. B	No. of	DIM. A	DIM. B	No. of	DIM. A	DIM. B	No. of	DIM. A	DIM. B
1	0.00	2.54	11	25.40	27.94	21	50.80	53.34	31	76.20	78.74
2	2.54	5.08	12	27.94	30.48	22	53.34	55.88	32	78.74	81.28
3	5.08	7.62	13	30.48	33.02	23	55.88	58.42	33	81.28	83.82
4	7.62	10.16	14	33.02	35.56	24	58.42	60.96	34	83.82	86.36
5	10.16	12.70	15	35.56	38.10	25	60.96	63.50	35	86.36	88.90
6	12.70	15.24	16	38.10	40.64	26	63.50	66.04	36	88.90	91.44
7	15.24	17.78	17	40.64	43.18	27	66.04	68.58	37	91.44	93.98
8	17.78	20.32	18	43.18	45.72	28	68.58	71.12	38	93.98	96.52
9	20.32	22.86	19	45.72	48.26	29	71.12	73.66	39	96.52	99.06
10	22.86	25.40	20	48.26	50.80	30	73.66	76.20	40	99.06	101.60